



Diamond Tub & Showers Spec Sheet

Model: T 604278 R/L, T 6042XX (Left Shown)

Description: Tub/Shower Combo 1 Piece Unit

Specifications

Model #	Material	Wall Finish	Pieces	Drain	Apron Height	Net Weight Lbs.
T 604278 R/L	Fiberglass/ Gelcoat	Smooth	1	L/R	20 1/2"	

Framing Dimensions

A	B	C	D
60"	19 5/8"	10"	42"

Sump Data

Top of Drain to Bottom of Overflow	Capacity to Overflow Gallons	Top Dimensions		Bottom Dimensions	
		Length	Width	Length	Width
15 1/4"	56.1	52 3/8"	30 1/8"	46 3/4"	23 7/8"

Enclosure Opening

Width	Height
56 3/4"	56 3/8"

Framing Specifications

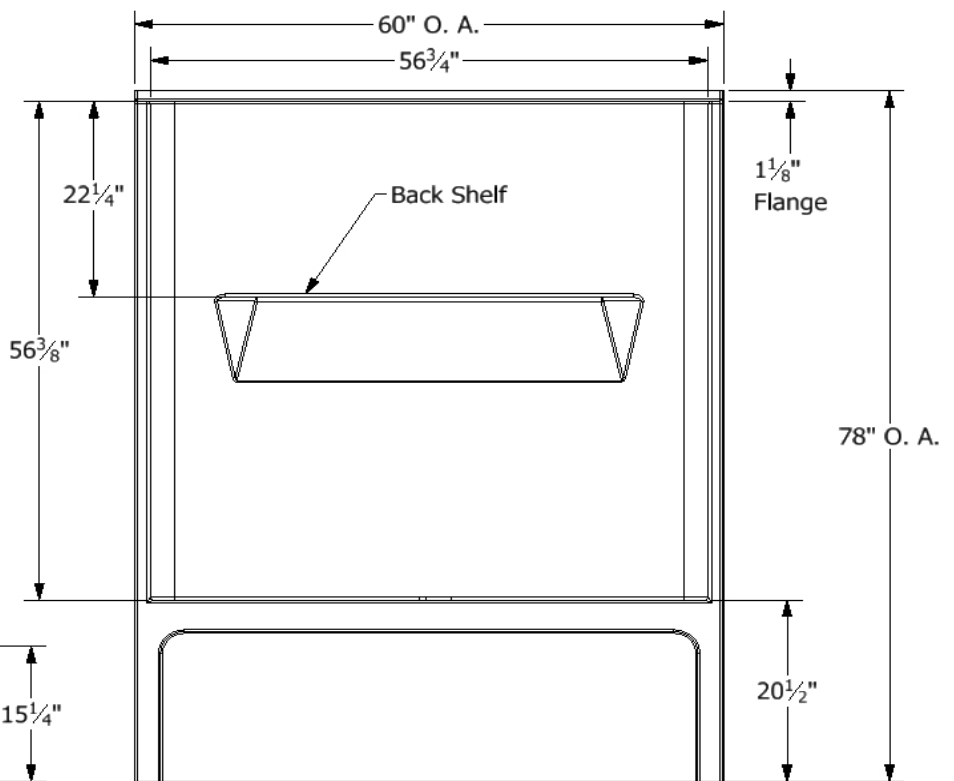
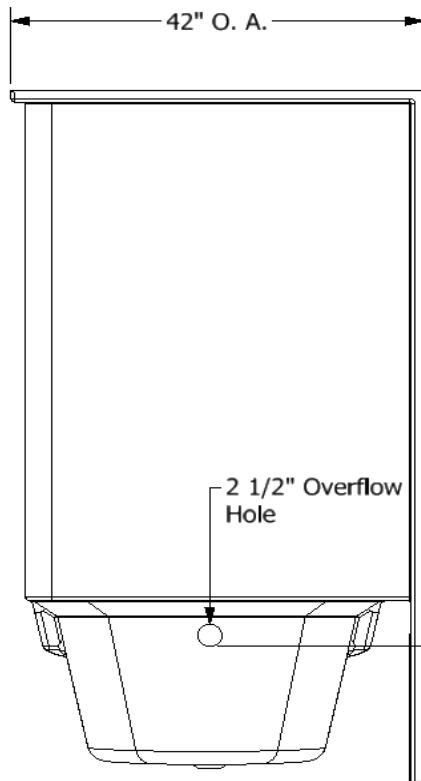
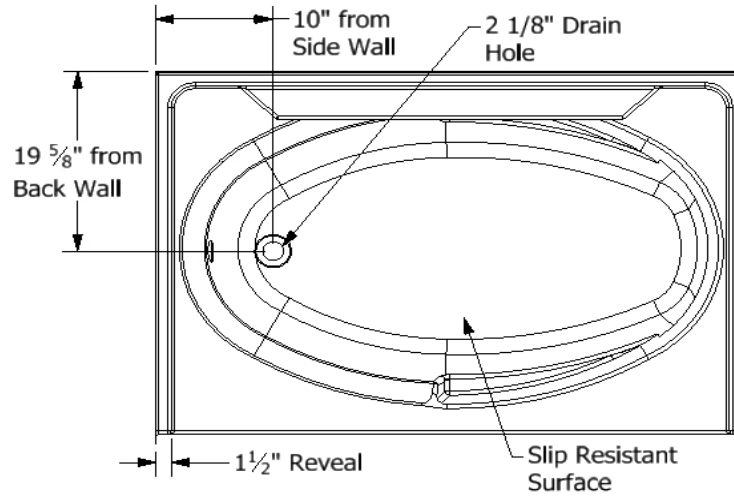
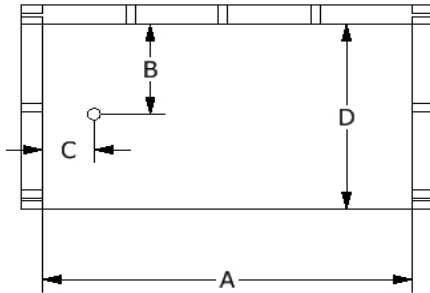

Certified to conform to ANSI Z124.1 and ASTM E-162 Flame Spread Rating 200 or less and is under a program of factory inspection.

Manufactured by Front Line Mfg., Inc. Warsaw, IN



5/29/19