



Diamond Tub & Showers Spec Sheet

Model: B 3635-6

Description: One Piece Shower Base

Specifications

Model #	Material	Wall Finish	Pieces	Drain	Threshold Height	Net Weight Lbs.
B 3635-6	Fiberglass/Gelcoat	Smooth	1	C	6"	
Enclosure Opening						
Width		Height				
35 3/4"		NA				

Framing Dimensions

A	B	C	D
36"	18"	17 1/4"	35 1/8"

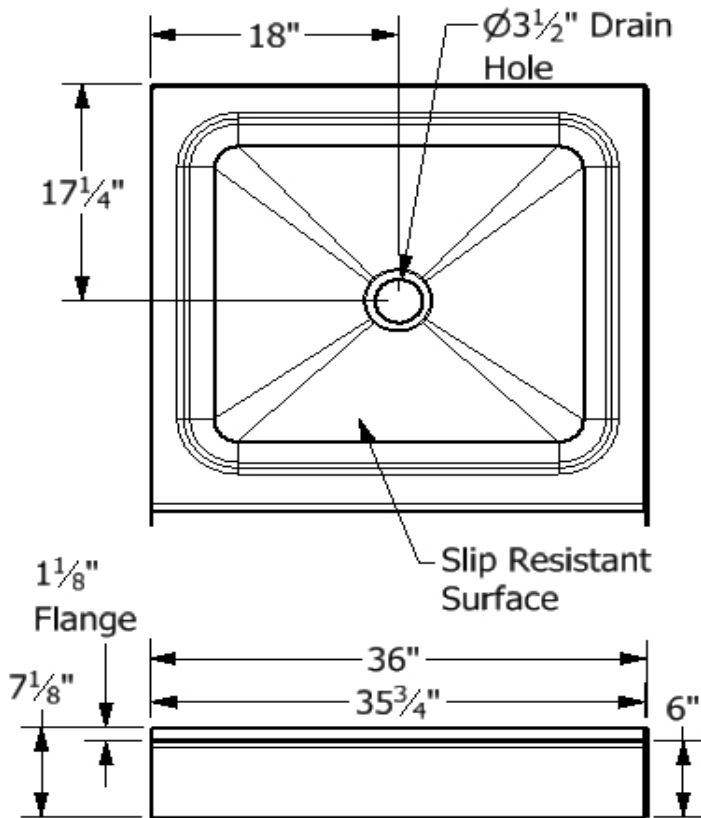

Framing Specifications

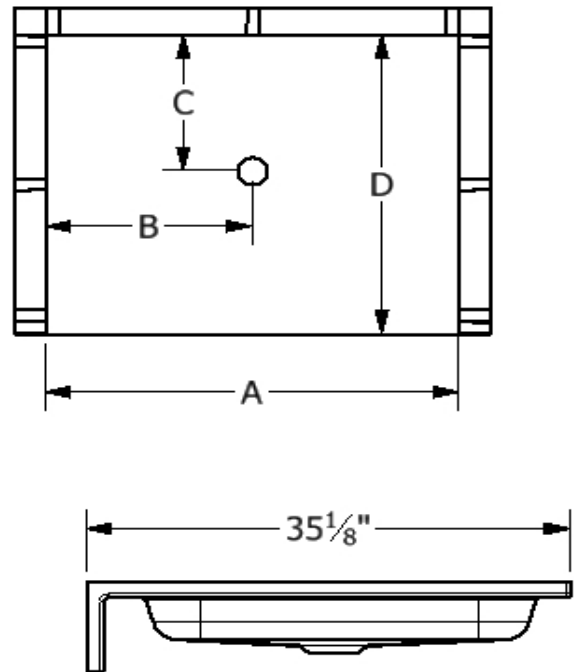

This product is tested by ICC-ES and is certified to conform to the requirements of CSA B45.5/IAMPO Z124 standard.

Manufactured by Frontline Mfg., Inc. Warsaw, IN



6/5/19